

USER MANUAL

KBUSF66BW BEER & WINE COOLER COMBO

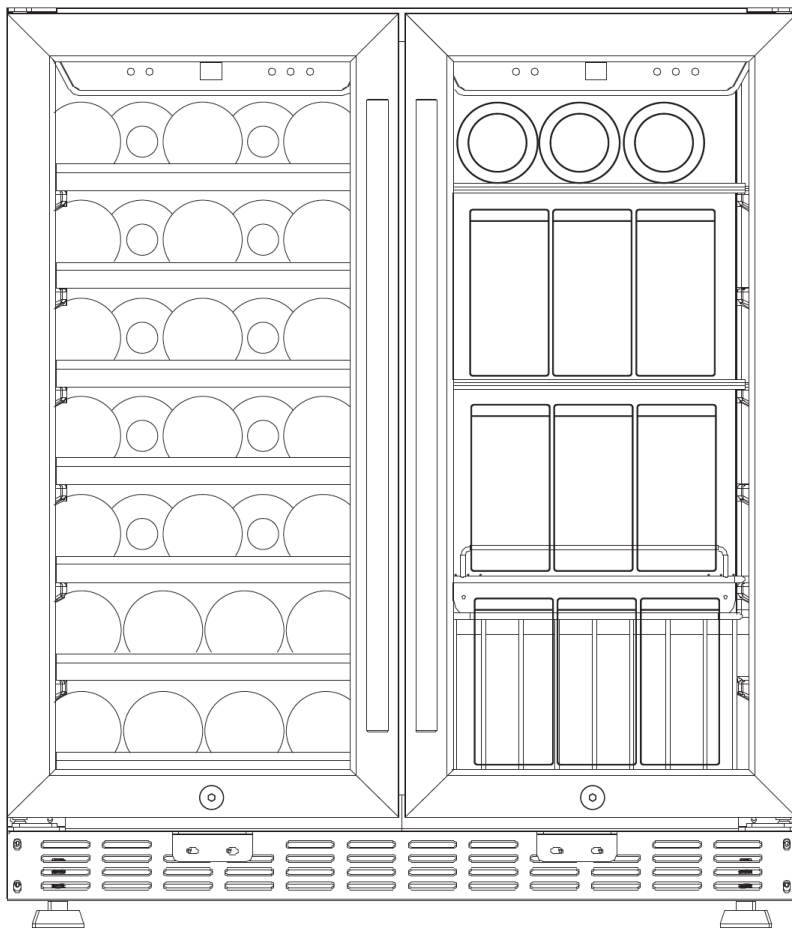

PLEASE NOTE:

EVERY TIME THE UNIT IS POWERED ON, THERE WILL BE A 6 MINUTE DELAY FOR THE COMPRESSOR TO START.

COMPRESSOR REFRIGERATORS



CONTENTS

Congratulations

Congratulations and thank you for choosing our KingsBottle refrigerators . We are sure you will find your new appliance a pleasure to use . Before installing and operating the refrigerator, we recommend that you read through this manual which provides a description of your refrigerator and its functions .

To avoid the risks that are always present when you use an electric appliance, it is important that the appliance is installed correctly and that you read the safety instructions carefully to avoid misuse and hazards .

We recommend that you keep this instruction booklet for future reference and pass it on to any future owners .

After unpacking the appliance, please inspect it to verify it is not damaged. If in doubt, do not use the appliance but contact us or your local customer care centre

TABLE OF CONTENTS

Chapter	Contents	Page
Part I	Important Safety & Pre-Use Instructions	3
Part II	Diagram & Description of Refrigerator	4
Part III	Installation Instructions	5-6
Part IV	Temperature Setting and Refrigerator Operating	7-8
Part V	Layout & Storage	9
PART VI	Maintenance	10
Part VII	Troubleshooting Guide	11
Part VIII	Technical Data	12
Part IX	Warranty Information	12

Prop. 65 Warning for California Residents



WARNING

Cancer and Reproductive Harm -
www.P65Warnings.ca.gov

PART I IMPORTANT SAFETY INSTRUCTIONS

Please read this user manual carefully and store in a handy place for later reference . The symbols you will see in this booklet have these meanings:



This symbol indicates information concerning your personal safety



This symbol indicates information on how to avoid damaging the appliance



This symbol indicates tips and information about use of the appliance



This symbol indicates tips and information about economical and ecological use of the appliance



TO REDUCE THE RISK OF FIRE, ELECTRICAL SHOCK, OR INJURY WHEN USING YOUR APPLIANCE, FOLLOW THESE BASIC PRECAUTIONS:

1. Read all instructions before using the refrigerator.
2. DANGER or WARNING: Risk of child entrapment. Child entrapment and suffocation are not only problems of the past. Junked or abandoned appliances are still dangerous... even if they will "just sit in the garage for a few days".
3. Before you throw away your old refrigerator:
 - Take off the door.
 - Leave the Shelves in pieces so that children may not climb inside easily.
4. Never allow children to operate, play with, or crawl inside the appliance.



1. The refrigerator must be plugged into its own dedicated 110-115V, 50/60Hz AC electrical outlet .
2. The plug must be accessible when the cooler is in position.
3. It is essential the power point is properly grounded . Consult a qualified electrician if you are unsure .
4. Don't use extension cords or adapter plugs with this cooler .
5. If the power cord is damaged, have it replaced by a qualified service technician .

6. Unplug the cooler before cleaning it, or changing the light bulb to avoid electric shock .
7. Never clean appliance parts with flammable fluids. The fumes can create a fire hazard or explosion.
8. Never unplug the cooler by pulling the electrical cord as this may damage it. Grip the plug firmly and pull straight out .
9. Choose a location for your cooler that isn't too cold . The ambient room temperature should be above 50°F .
10. Stand your cooler in a dry place – avoid areas of high moisture or humidity .
11. Don't put the cooler in frosty or unprotected areas like a garage or on the verandah .
12. Keep the cooler out of direct sunlight .
13. Don't locate the cooler near stoves, fires or heaters .
14. Do not store in the vicinity of any other appliance. Do not store near gasoline or any other flammable vapors. The fumes can create a fire hazard or explosion.
15. When installed correctly, your cooler should:
 - Have adequate space at the back and sides for air circulation. (See Page 5)
 - Be aligned to the surrounding cupboards .
 - Have doors that will self-close from a partially open position
16. Please inspect and clean the filter in front venting grill every month. Failure to clean will void the warranty and increase the running costs.

BEFORE USING YOUR REFRIGERATOR

1. Remove the exterior and interior packing.
2. Before connecting the refrigerator to the power source, let it stand upright for approximately 24 hours. This will reduce the possibility of a malfunction in the cooling system from handling during transportation.
3. Clean the interior surface with lukewarm water using a soft cloth.

FEATURES

PART II DIAGRAM & DESCRIPTION OF REFRIGERATOR

BEER & WINE COMBO REFRIGERATOR MODEL: KBUSF66BW

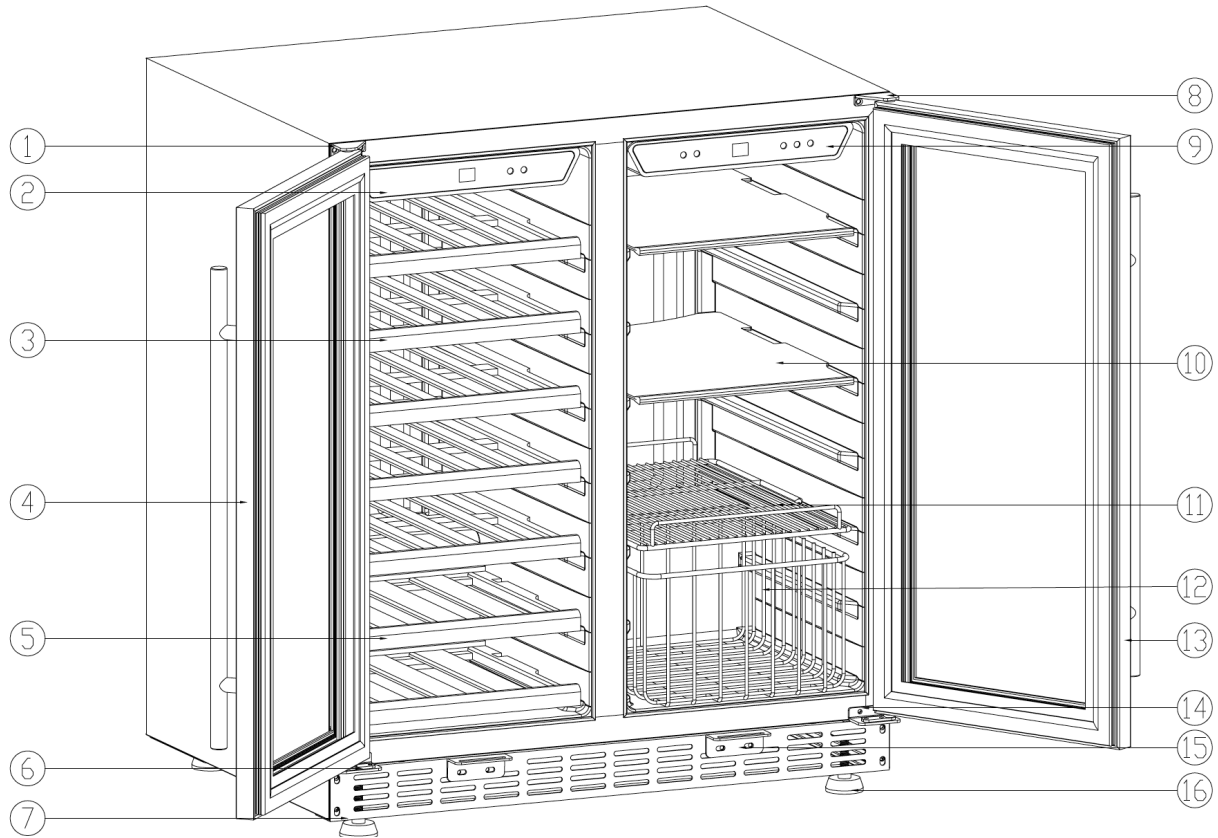

- | | | | |
|------------------------------|------------------------|-----------------------|----------------------|
| 1 Left upper hinge | 5 Small wooden shelf | 9 Right control panel | 13 Right door |
| 2 Left control panel | 6 Left lower hinge | 10 Glass shelf | 14 Right lower hinge |
| 3 Large wooden shelf | 7 Front venting grille | 11 Wire Shelf | 15 Lock hook |
| 4 Left door with handle/lock | 8 Right upper hinge | 12 Wire basket | 16 Stand feet |

YOUR REFRIGERATOR ALSO INCLUDES THE FOLLOWING:

- Instruction manual
- Keys

COMPRESSOR REFRIGERATORS

INSTALLATION

PART III INSTALLATION INSTRUCTIONS

CUTOUT DIMENSION ILLUSTRATED (MINIMUM CAVITY SPACE REQUIRED)

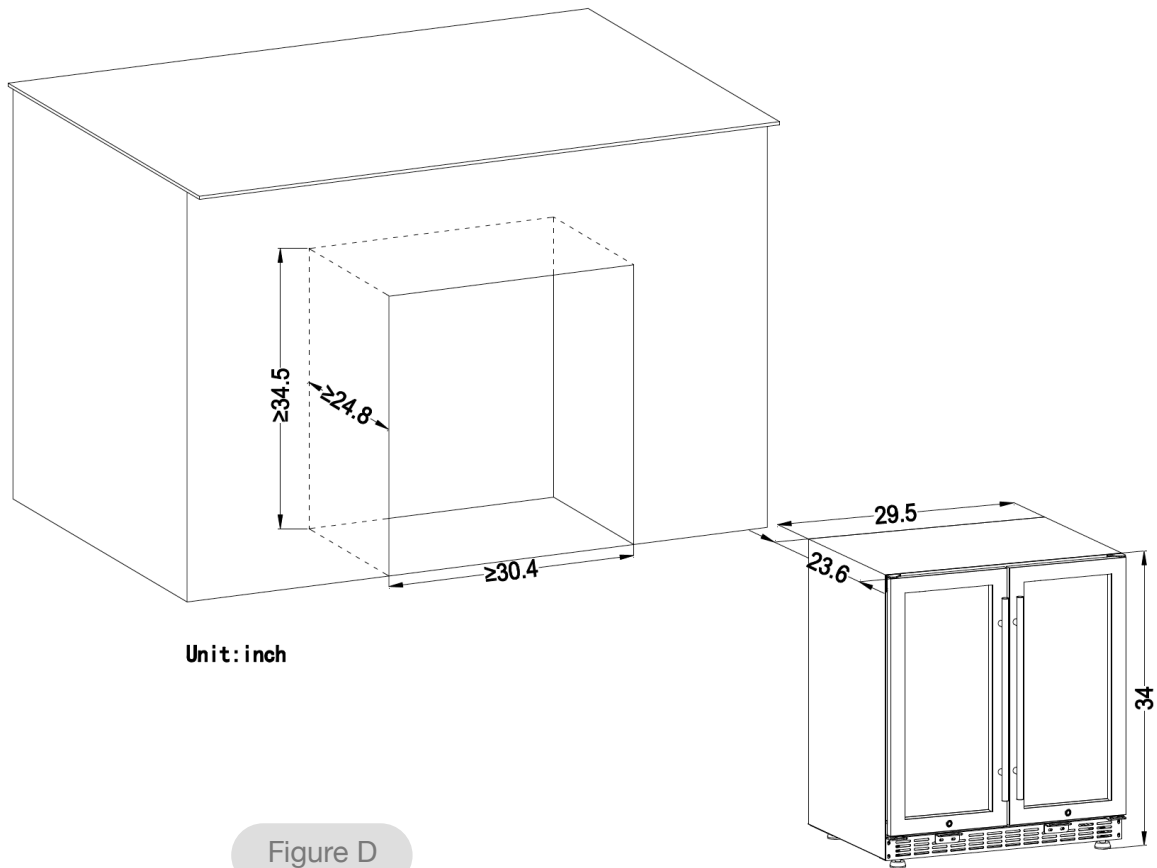

The cutout dimension illustrated in figure (D) allows for door swing and access to the pull-out shelves when installed as a built-in appliance. If installing between frameless cabinets, a 1/2" wide filler strip or side panel may be needed on hinge side. The filler strip will act as a spacer between the appliance case and adjacent cabinet door swing.

Failure to allow minimum clearances will void all warranties

INSTALLATION

PART III INSTALLATION INSTRUCTIONS

INSTALLING YOUR REFRIGERATOR

1. Move the unit into its final position .
2. If the unit is not tilting back, minor adjustments can be made to the leveling legs.
3. Compare the alignment of the appliance to the surrounding cupboard . The top of the appliance should be level from side to side (see diagram below) .

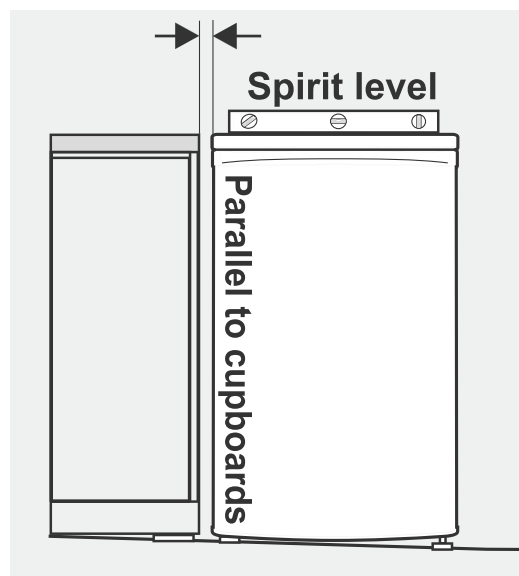

4. If the unit now rocks from one corner to the opposite rear corner, this means that the floor is uneven. You may need to put some packing under the ridge to the rear of the appliance . You could use thin pieces of solid material such as thin board, vinyl floor tiles or laminate .
5. You may now need to fine tune the installation by repeating steps 2, 3 and 4 .
6. Wipe off any dust that has accumulated during shipping and clean following the directions in Part VI (Care & Maintenance)
7. Plug the appliance into the power point. Don't use a double adaptor or extension cord .
8. It is recommended that you let the unit for rest an hour or two before you put any wine bottles in it . This will confirm that it is operating correctly and make the conditions appropriate for wine storage .

Congratulations! You have successfully installed your refrigerator.

DOOR LOCK

This unit comes with an optional key lock. The keys are located inside the plastic bag that contains the user manual. To lock the door, simply reverse the operation making sure the metal pin is engaged completely. Then remove the key and place it in a secure place for safekeeping. To unlock the door, insert the key into the lock and turn counterclockwise.

PART IV OPERATING YOUR REFRIGERATOR

LEFT :

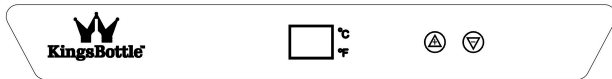

RIGHT :

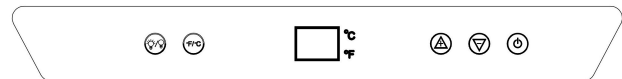

Each refrigerator includes an operating panel on the front of the unit. This operating panel includes several features to operate and control the temperature of both the LEFT and RIGHT zones of the refrigerator.

The operating panel includes the following features:

ON/OFF: Press over 3 seconds to turn the refrigerator power ON or OFF.

°C/°F: Select temperature display format Fahrenheit or Celsius.

LIGHT: Turns the interior cabinet light on or off. Light will turn OFF automatically in 10 minutes.

CAUTION:

BEFORE YOU START: The refrigerator should be placed in a location where the ambient temperature is between 32 - 100 degree Fahrenheit. If the ambient temperature is above or below this range, the performance of the unit may be affected. For example, placing your unit in extreme cold or hot conditions may cause interior temperatures to fluctuate.

SETTING THE TEMPERATURE CONTROL

1. Make sure power cord is connected to a properly grounded outlet.
2. Turn Power ON.
3. Each zone is independently controlled.
 - LEFT Zone: The temperature setting can be adjusted between 41°F to 64°F
 - RIGHT Zone: The temperature setting can be adjusted between 34°F to 64°F
4. Set the temperature of the LEFT Zone or RIGHT Zone as you desire by pushing the UP or DOWN button. When you push the two buttons for the first time, the LED readout will show the original temperature set at previous time.
5. Once you have set the desired temperature, wait 5 seconds. The temperature shown in the both LEFT and RIGHT zone display panels will automatically switch to show the actual temperature inside the unit. The actual temperature will always be shown until the next time you press the UP or DOWN button to change the temperature settings.

NOTE: The desired temperatures may fluctuate depending on whether the interior light is ON or OFF, the ambient temperature, the location of unit and the orientation of the bottles. The display is just a guide, be guided by how cold your drinks are at consumption. Remember units go into defrost mode and this will show a higher display, it's only for short periods and doesn't have time to effect drink temperature. In general once unit has settled it will keep products within 5°F (2°C) of the set temp easily in temperatures up to and beyond 100°F (38°C) .

OPERATION

TEMPERATURE SETTINGS FOR WINE SERVICE

1. Different varietals of wine require different temperature settings. The recommended temperature ranges for serving different varietals of wine are listed below. Your refrigerator will indicate when you have set the LEFT/RIGHT zones to the below temperature ranges.
 - Red Wines: 52-64°F
 - White Wines: 44-51°F
 - Sparkle Wines: 41-43°F
2. If you set the LEFT or RIGHT zone between 52-64°F, the LED light next to "RED" will light up, indicating that you are within the recommended range for serving Red Wines.
3. If you set the LEFT or RIGHT zone between 44-51°F, the LED light next to "WHITE" will light up, indicating that you are within the recommended range for serving White Wines.
4. If you set the LEFT or RIGHT zone between 41-43°F, the LED light next to "SPARKLE" will light up, indicating that you are within the recommended range for serving Sparkle Wines

CAUTION

1. In the event of a power interruption, all previous temperature settings will be automatically saved and each compartment will return to the previous temperature setting.
2. If the unit is unplugged, loses power, or is turned off, there will be a 6 minute delay for the compressor to restart after the unit is powered ON.
3. When you use the refrigerator for the first time or restart the refrigerator after having been shut off for a long time, there will be a few degrees variance between the temperature you select and the one indicated on the LED readout for the first few hours of operation. After a few hours of operation, the temperature will normalize to the displayed temperature.

PART V LAYOUT AND STORAGE

YOUR CABINET WAS DESIGNED TO STORE A MAXIMUM NUMBER OF BOTTLES SECURELY. WE RECOMMEND THAT YOU OBSERVE THE TIPS BELOW TO OPTIMIZE LOADING.

1. Disperse your bottles even so as not to concentrate weight in any one area. Also, be careful that your bottles do not touch either the back of the cabinet or the step at the bottom.
2. Also make sure that bottles are not all grouped together either at the top or bottom of the cabinet.
3. A cooler that is full and has nice allowance for air movement will work more efficiently.
4. Never try to adjust shelf with bottles still on it.

TO REMOVE A ROLLING SHELF:

1. Remove all bottles
2. Pull the shelf out as far as possible
3. Never try to pull out more than one rolling shelf at a time.
4. Remove the shelf

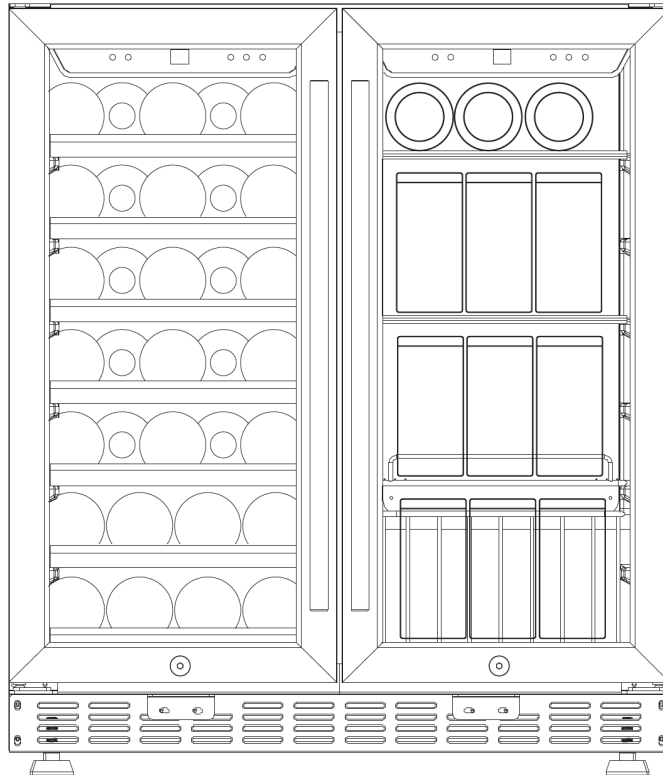

PLEASE NOTE

Before modifying your cabinet's original configuration in any way, be sure to ask your dealer for advice.

MAINTENANCE

PART VI CARE AND MAINTENANCE

CLEANING YOUR REFRIGERATOR



BEFORE CLEANING: Turn off the power, unplug the appliance, and remove all items including all shelves.

- Wash the inside surfaces with warm water and baking soda solution. The solution should be about 2 tablespoons of baking soda with a quart of water.
- Wash the shelves with a mild detergent solution.
- Wring excess water out of the sponge or cloth when cleaning area of the controls, or any electrical parts.
- Wash the outside cabinet with warm water and mild liquid detergent. Rinse well and wipe dry with a clean soft cloth.
- After installation, **we recommend that owners apply a thin layer of Olive Oil with a clean rag, to all exposed Stainless Steel areas.** This should then be polished in and buffed off with another clean rag to a non-oily finish. This process will aid protection against dirt and other corrosive contaminants, by providing a temporary food-safe shield. The Olive Oil layer also makes later polishing and removal of fingerprints easier. This process should be repeated frequently every 3-4 months. ALL stainless steel can rust, it is a myth that stainless steel doesn't rust.

POWER FAILURE

Most power failures are corrected within a few hours and should not affect the temperature of your appliance if you minimize the number of times the door is opened. If the power is going to be off for a longer period of time, you need to take the proper steps to protect your contents.

VACATION TIME

Short vacations: You may leave the refrigerator operating during vacations of less than three weeks.

Long vacations: If the appliance will not be used for several months, remove all items and turn off the appliance. Clean and dry the interior thoroughly. To prevent mold growth, leave the door open slightly, blocking it open if necessary.

MOVING YOUR Refrigerator

1. Remove all items.
2. Securely tape down all loose items (shelves) inside your appliance.
3. Turn the adjustable leg up to the base to avoid damage.
4. Tape the door shut.
5. Be sure the appliance stays secure in the upright position during transportation. Also protect the outside of the appliance with a blanket or similar item.

ENERGY SAVING TIPS

1. The refrigerator should be located in the coolest area of the room, away from heat producing appliances, and away from direct sunlight. Ventilation at rear also helps a lot with energy usage, so create a positive air flow where possible, although with this range they are designed to be fully built in.
2. When you are not using fridge during weekdays etc. it is recommended to set the temp at a higher level, so set at 64°F (18°C) during periods of non usage, this will not only mean less run time, it also still keeps drinks at a temp that won't be spoiled. It saves energy also which these days is a growing concern for most households.
3. Keep the cooler stocked, an empty cooler will run longer, believe it or not.

TROUBLESHOOTING GUIDE

PART VII TROUBLESHOOTING GUIDE

PROBLEM	POSSIBLE CAUSE	Solution
Refrigerator does not operate	1. Not plugged in 2. The appliance is turned OFF at the control panel 3. The circuit breaker has tripped or a fuse has blown out	Press ON/OFF Check and make sure the power plug is well connected Ask an engineer for help
Refrigerator is not cold enough; can not cool down to the preset temp.	Compressor does not start	ask an engineer for help / check the connection of the compressor
	Compressor self-protected and has stopped operating	The ambient temperature is too high (over 100°F degree) The air venting is not smooth, check that the air duct is not blocked Fan operates slowly or is faulty and has stopped operating. The door is not closed completely, or the door opened too long The compressor, or its components are faulty
	Fans stop working or operate at low speed	Ask an engineer for help. Power the refrigerator ON and OFF. Check the fan and whether the voltage is normal. If the voltage is normal, then the fan should be damaged
	Evaporator ices up	Turn OFF the refrigerator for one hour and open the door. The ice on the evaporator will melt. Check the door seal for any air gaps.
	Door is not closed properly	Check the door lock, shelves, or other objects, make sure door is well closed. Check the rubber seal for any air gaps. Check the door hinges, make sure they are not loose
	Condenser is dusty	Wash and clean the condenser
	Cooling system faulty (Gas leakage or blockage)	Ask an engineer for help
Compressor starts and stops frequently	The door gasket does not seal properly.	Use low heat on a hair dryer to make the door seal take shape.
	The sensor connection is wrong.	Read the wiring diagram to make the correct connection of sensor
	The sensor is faulty.	Replace with a new sensor
	The door is opened too often.	Reduce the times / frequency of door openings.
The light does not work.	Not plugged in, or the light button is "OFF". Light itself faulty.	Check and make sure the light button is ON, or ask an engineer for help.
The Refrigerator seems to make too much noise.	The stand feet is not leveling, vibrations lead to noise	Adjust the stand feet and ensure they are level.
	Copper pipe hits other objects and makes noise	Gently adjust the position of the pipe.
	When the compressor shuts down or starts, it is normal for noise from the vibrations generated by the internal moving parts due to inertia. A liquid plumbing noise may come from the flow of the refrigerators gases, which is normal. As each cycle ends, you may hear gurgling sounds	Take no action Take no action
The door will not close properly.	Door is blocked by the door lock, shelves, or other objects.	Remove the barrier
	Door sealing rubber is deformed	Repair or replace the rubber seal
	Door hinges are not loose.	Adjust and fasten the hinges.
Ice up	Outlet / suction outlet blockage	Remove the barrier
	Fans stop working or operate at low speed.	Ask an engineer for help. Power the refrigerator ON and OFF. Check the fan and the voltage. If the voltage is normal, the fan may be damaged.
	The door gasket does not seal properly; or door is opened too often	Use low heat on a hair dryer to make the door seal take shape.
	Gas leakage or cooling system blockage	Ask an engineer for help
External cabinet seems too hot	Ambient temperature is too high, or direct sunshine	Operating conditions need to be improved
	Front grill outlet / suction outlet blockage	Remove the barrier
	Fans stop working or low speed operating	Ask engineer for help, power on the refrigerator, check the fan whether the voltage is normal or not. If the voltage is normal, the fan should be damage
Water drop on glass door	Ambient humidity is high	Use a soft cloth to clean the water
	Door is opened too often	Reduce the times / frequency of door opening.
	The door gasket does not seal properly	Use low heat on a hair dryer to make the door seal take shape.

TECHNICAL DATA

PART X TECHNICAL DATA

KBUSF66BW	
General Info:	
Capacity	6.50 CF (184 Liter)
Bottles to Store	33 BOTTLES + 70 cans
Installation Type	Built-in
Shelves	7 wood shelves, 2 glass shelves + 1 wire shelf + 1 wire basket
Temperature zone	Dual Zone
Temperature Range	Left side: 41-64 Fahrenheit; Right side: 34-64 Fahrenheit
Climate Type	ST;N;SN
Noise Level (dB)	<42 dB
Features:	
Cooling System	Compressor
Control	Digital Thermostatic Control
Circulating Fans	Yes
LED Light	Blue LED
Door Type	Two-layer glass door with one Low-E
Security Lock	yes
Electrical:	
Rated Current	0.9A
Rated Power Input	90Watts
Refrigerant	R600A
Energy Consumption	1.23 Kw*h/24hr
Dimensions:	
Unit Size	29.6"Wx23.6"Dx34.5"H (750W*600D*875H mm)
Net Weight	132 lb (60 kg)

PART IX WARRANTY INFORMATION

Registering online is quick and easy!

<https://kingsbottle.com/apps/product-registration>

Please speak to your retailer before calling us if you did not purchase your refrigerator directly from **KingsBottle**.

Who is covered: This warranty is extended only to the original end-user purchaser or the person receiving the product as a gift, and shall not be extended to any other person or transferee.

Limited warranty – If your refrigerator is not operating properly, KingsBottle reserves the right to repair or replace the refrigerator. KingsBottle may request the consumer to contact a local refrigeration company to service the refrigerator. All cost for labor and materials is covered for 3-year from the date of receipt. If KingsBottle deems the unit not repairable, KingsBottle will use the value of your original order toward a replacement. For customer service, please e-mail us via service@kingsbottle.com.

The limited warranty does not cover: Damage due to such things as accident, misuse, abuse, mishandling, neglect, unauthorized repair or any other cause beyond the control of the seller whether similar or dissimilar to the foregoing. Purchaser understands and acknowledges that the goods sold here are WINE & BEVERAGE COOLERS, which house beer and other wines. Purchaser assumes all the risk of using these units, including risk of spoilage, humidity variations, temperature variations, leaks, fires, water damage, mold, mildew, dryness and similar perils that may occur.

SPECIAL NOTE: Warranty is only honored for the unit which is purchased and used in United States of America. And, if your product was purchased at any 3rd party retailer and not directly from KingsBottle, we do not offer an extended warranty policy. You **MUST** contact the retailer of purchase directly. In the event your retailer does not offer an extended warranty plan, we recommend you contact a third party warranty provider. However, regardless of point of purchase, all KingsBottle coolers are backed by a TWO YEAR manufacturer's warranty from date of sale.